

LASER

Water Softener Installation Guide



<i>Contents</i>	<i>Page</i>
<u>CONSUMER INFORMATION</u>	
Introduction	3
Choice of Salt	3
Control Operation and Layout	4
Changing the Time of Day	4
Manual Regeneration	5
Specification	5
<u>INSTALLATION & COMMISSIONING INFORMATION</u>	
Before you start	6
Installation	
inc positioning, connections, electrics and programming	7,8,9
Control Operation & Layout	8
Commissioning and start Up	9
Advanced Programming	
inc quick cycling regeneration and system reset	9,10

DATE SOFTENER INSTALLED

.....

We suggest you keep this manual for future reference.

Thank you for choosing a Laser Water Softener

CONSUMER INFORMATION

Introduction

Thank you for purchasing this Laser water softener. Please take the time to read this guide as we think it will help you have years of trouble free softened water.

Make sure the softener has been installed and commissioned by a competent person.

Once commissioned all you need to do is check the softener has enough water softener salt.



Figure 1: Laser Softener

Choice of Salt

The Laser softener uses salt to regenerate. We recommend softener salt should conform to the European Standard EN 973.

Block salt: If you are using block salt leave the block salt holder in place. Two blocks fit in the holder, one on each side. After a couple of regenerations the blocks dissolve away and slide down the holder. As soon as there is room put in new blocks above the old ones (typically when the salt level drops to one of the holes).

Tablet salt If you using tablet salt make sure the block salt holder has been removed. Keep the softener topped up with salt (holds about 20Kgs). The salt should always be higher than the water level.

Control Operation & Layout

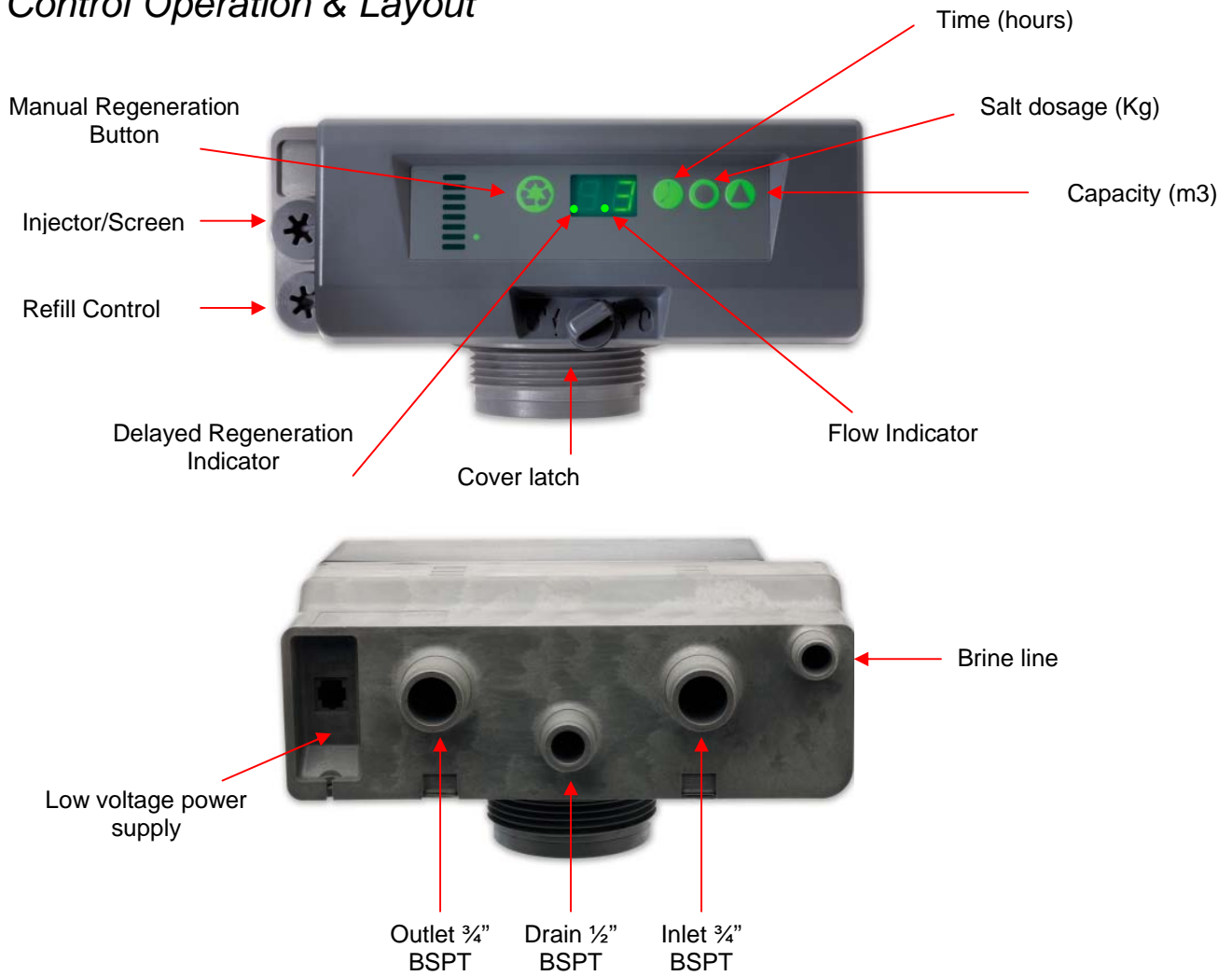
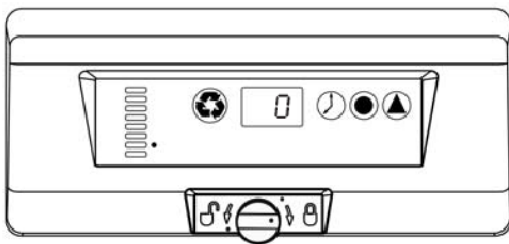



Figure 2a & b Controls and connections

Power Loss Memory Retention: The time will remain in the memory for 6 to 24 hours.. If it's lost, the Time of Day will reset to "0" immediately after the power is restored. The Time of Day must then be reset to ensure the regeneration occurs at the 0.00. **Note: all other programmed parameters are stored and are retained during power outages.**

Changing the Time of Day



Time of Day: Press  until the hour appears then release.

Range: 0 through to 23 hours.

Note: The elapsed minutes will reset to zero when the hours are changed

More advanced programming features are detailed in the installation details at the back of this manual.

Manual Regeneration

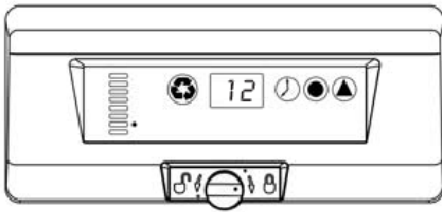

Delayed Regeneration: Press and release  to program a delayed regeneration. The system will regenerate at the next time of regeneration (02.00 (am)) Repeat the procedure to disable the delayed Regen. Regen dot blinks when delayed regeneration is on.

Immediate Regeneration: Press and hold the  for 3 seconds to initiate regeneration. The control will display a cascading symbol (- -) as it cycles to backwash.

Specification

Nominal flow rate @ 1.05 bar drop	1500 l/hr
Peak flow rate	2900 l/hr
Backwash @ 1.05 bar drop	400 l/hr
Inlet / outlet connections	3/4" BSPT, Male
Drain line connections	3/4" BSPT, Male
Operating Pressure	1.5 – 6 bar
Water Temperature	2 – 38 °C
Ambient Temperature	2 – 50 °C
Height	507mm
Width	282mm
Depth	440mm
Weight (shipping)	23Kg
Power consumption (max)	4W max
Power consumption (ave)	less than 1W
Electrical rating	12V 50Hz
Resin volume	15 l
Regeneration Time	Approx 46 Min
Water Used per Regeneration	59 Litres
Salt Used per Regeneration	1.5 Kg
Hardness Capacity– see programming section (@ 300ppm CaCO3)	2.2 m3
Exchange Capacity	0.66 Kg
Brine Efficiency	440 g
Sizing (120 litres/person/day, 300 ppm hardness)	>18 person days

Maintenance

Please follow the advice below to maintain your softener.

- Check the salt level is above the water level weekly. If it isn't, add salt.
- Check for leaks and that the drain line is free of debris monthly.

- Perform a regeneration if the softener hasn't been used for 96hrs.

To shut down the softener

- Disconnect the power by unplugging the AC adaptor from its power source. If necessary put the softener in bypass.

INSTALLATION & COMMISSIONING INFORMATION

Before You Start

- inspect the Water Softener for shipping damage or shortages.
- Follow all the applicable Plumbing and Electrical regulations when installing the Water Softener. If at all in doubt, refer to the relevant WRAS information www.wras.co.uk.
- The Water Softener is not intended for the treatment of water that is microbiologically unsafe or of unknown quality without adequate disinfection before or after the Water Softener and is to be used *only* for potable water.
- Use caution when installing soldered metal piping near the Water Softener. Heat can adversely affect the plastic control valve system. Be sure all soldered pipes are fully cooled before attaching the plastic valve to the plumbing.
- All plastic connections should be hand tightened. PTFE tape may be used on connections that do not use an "O" ring seal. Do not use pipe or dope type sealants on the valve body. Do not use pliers or pipe wrenches.
- Minimum pipe run to a water heater should be more than 3 meters to prevent backup of hot water into system.
- Only use the power transformer supplied with the Water Softener.
- The power outlet must be earthed. Install an appropriate earthing strap across the inlet and outlet piping of the Water Softener to ensure proper earth is maintained.
- Observe drain line requirements. The drain line must be a minimum of ½" diameter. Use ¾" pipe if the total length of the drain line exceeds 6 meters.
- Do not support the weight of the Laser on the control valve connections or plumbing.
- Protect the softener, softener drain and all other components from the effects of frost. Damage from freezing will void your Water Softener warranty.
- Keep the media vessel in the upright position. Do not turn upside down or drop. Turning the vessel upside down or laying the vessel on its side can cause media to enter the valve.

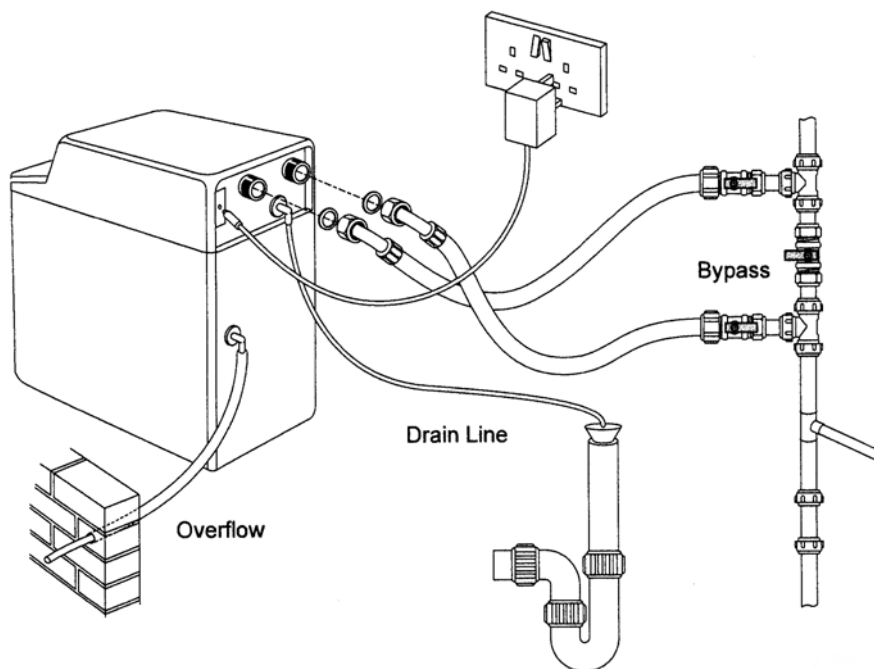

Figure 3: Typical Installation

Installation

It is recommended that your water softener is installed by a professional plumber. The installation guide is written to help the professional installer and assumes that this person has a working knowledge of hydraulic softeners and domestic plumbing systems.

Positioning the water softener

- Measure your water softener and the space where it will be installed. Remember to allow extra space for connecting pipe work when you do your calculations and access for future servicing and topping up salt.
- Keep the distance of the incoming main and drainage to a minimum.
- The weight of the water softener is greatly increased when fully operational and filled with salt so this needs to be taken into account when choosing where to site the softener.
- Your Laser softener is designed to operate effectively with an incoming water pressure of between 1.5 and 6 bar. If your water supply is likely to fall outside these parameters we recommend that a booster pump or pressure reducing valve should be fitted accordingly.
- Do not install your water softener next to a boiler or other heat source where the ambient temperature will exceed 40' C

Bypass Connections.

- A bypass loop should be installed on all Laser softeners. The bypass valve isolates the Water Softener from the water system and provides un-softened water to the water system during routine maintenance and servicing procedures. See figure 3..

Loft installation.

- The water softener may be installed in a loft or roof cavity but must be situated within a safety bund tank of not less than 100 litre capacity. This tank should also be mounted on a board strong enough to spread the weight over a load bearing wall.

Drain Line Connection.

- The unit should be above and not more than 6 meters from the drain. Use an appropriate adapter fitting to connect 1.3cm plastic tubing to the drain line connection of the control valve.
- The drain line may be elevated up to 1.8 meters providing the run does not exceed 4.6 meters and the water pressure at the softener is not less than 2.76 bar. Elevation can increase by 61cm for each additional 0.69 bar of water pressure at the drain connector.
- Where the drain line is elevated but empties into a drain below the level of the control valve, form an 18cm loop at the far end of the line so that the bottom of the loop is level with the drain line connection. This will provide an adequate siphon tap.
- Where the drain empties into an overhead sewer line, a sing-type trap must be used.
- Secure the end of the drain line to prevent it from moving.

Safety Devices

A Backflow Prevention Device is required which has an air gap of 20 mm minimum on both the independent regenerant drain and the brine tank overflow. The device needs to be in accordance with EN 1717. The backflow prevention device is required to protect public water from contamination.

Drinking Water

- When fitting your water softener, allowance should be made for at least one drinking water tap that is not fed by the water softener. Where practical this should be at the kitchen sink but a utility room or other alternative will suffice.
- It is recommended that people on a low sodium diet should not drink artificially softened water. Water used for mixing infant powder for babies must only be taken from the un-softened water as softened water contains an increased level of sodium to which young babies have a limited tolerance.

Electrical Connection

- The Laser water softener operates on low voltage via a plug in transformer. Do not use any other transformer except the one supplied with the softener.

Note: Power interruptions of longer than 6 hours may cause the Time of Day to be lost. When the power is restored, the control will briefly display the two digit model number and then display the Time of Day setting as "O". The Time of Day will need to be programmed

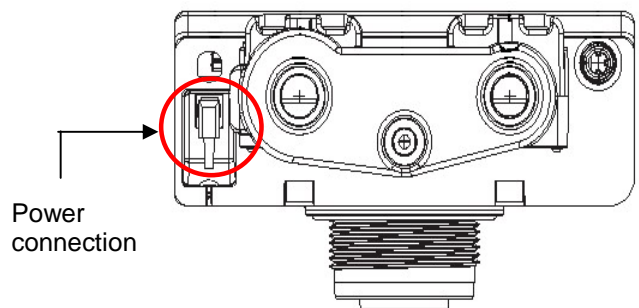

Programming

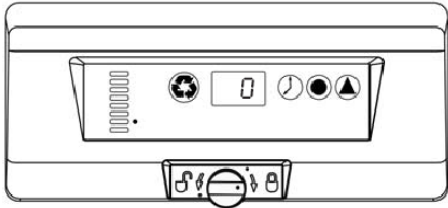

Time of Day: Press  until the hour appears then release.
Range: 0 through to 23 hours.
Note: The elapsed minutes will reset to zero when the hours are changed

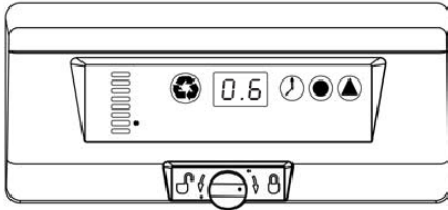

Salt Dosage: Press  until 1.5 Kg appears then release
Range: 0.2 kg to 6.0 kg salt dosage appears then release.
PLEASE check this is set to 1.5 (Kg)

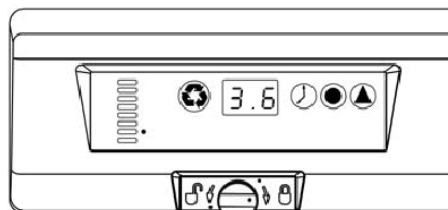

Capacity (m3): Press  until the desired setting is reached then release.
Range: 0.40 to 9.5 m³
See below for settings

Capacity = 660 divided by the hardness in ppm CaCO₃

Eg at 300ppm hard, Capacity = 660/300 = 2.2 (m³) so set capacity to 2.2 (typical for London area)

Programming is now complete.



NOTE: During programming if a button is not pushed for 5 seconds, the control returns to the normal operation mode and displays the Time of Day.

Commissioning and Start-up

Lift the salt lid and pour 4½ litres of clean water into softener. Do not put the salt in yet.

1. Make sure the supply water for the system is off.
2. Press and hold the  button on the controller for 3 seconds. This will initiate a manual regeneration, and cycle to the backwash position.
3. With the water softener in backwash, open the water supply valve very slowly to approximately ¼ open position. Water will begin to enter the media vessel. Air will begin to be purged to drain as the media vessel fills with water. When all of the air has been purged from the media vessel (water begins to flow steadily from the drain line), open the main supply valve all the way. This will purge the final air from the tank.
4. After the backwash (approximately 1 minute) the system will move in to brine draw. At this point the water in the bottom of the softener will be slowly drawn in and the level should drop. This will take about 10 minutes. If the water is drawn up then this proves there are no air leaks in the system

Note: there could be up to a centimetre height of water left in the softener at the end of this cycle which is OK.





- After 15 minutes of the brine draw with most of the water having disappeared add the salt – either block salt in the holders or tablet salt
- Allow the regeneration to proceed to the end (after the brine draw a measured amount of water will flow into the softener and dissolve 1.5 Kg of the salt ready for the next regeneration. The system is now ready.

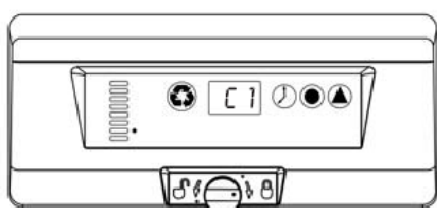

Advanced Programming Procedures

Quick Cycling the Control (in regeneration).



Quick Cycling: Press and hold  for 3 seconds to initiate an immediate regeneration. The control will cycle to the backwash cycle.







- Press and release the  to display C1
- Simultaneously press then release  and  to move the control to the next cycle.
- Press and release  to display C2.
- Repeat steps 2 and 3 to cycle through each position.

Quick Cycle to Service Position: Simultaneously press  and  hold for 3 seconds during any regeneration cycle. The control will skip the remaining regeneration cycles and return to the service position.

Regeneration Cycle.

Cycle No.	Cycle Description	Notes
C1	Backwash	Cleans debris out of softener
C2	Draw and slow rinse	Uses brine to recharge the softener
C3	Depressurisation	Equalises water pressures
C4	Fast rinse	Rinses out any remaining brine
C5	2 nd backwash	
C6	2 nd rinse	
C7	Brine refill	Makes brine ready for next regeneration

System Reset:- Please contact your installer before changing the system setting.

- Press and hold the  and  buttons simultaneously for 3 seconds.
- A small “u” will be displayed in the left digit. (Should be u3).
- Press the  button to scroll through the settings available, release the button when “u0” is displayed. Wait 5 seconds – this resets the memory.
- The display will revert to the Time of Day setting. The control has now defaulted to system u1 setting (needs to be reset to 3 – see next step)
- Press and hold the  and  buttons simultaneously for 3 seconds.
- A small “u” will be displayed in the left digit. The right digit will display the current system setting. Set this to 3 by pressing the  button